



Johnson County Building Officials Association

Residential Decks

Permit and Construction Guidelines under the 2018 IRC



Produced by TimberTek Consulting

This publication is endorsed by:

Johnson County Building Officials Association

For use in Johnson County, Kansas jurisdictions

USES AND LIMITATIONS OF THIS DOCUMENT

The purpose of this document is to provide the public, contractors, homeowners and city officials with deck construction guidelines that will be accepted by the majority of jurisdictions within the Johnson County and Kansas City metropolitan area. Members of the Johnson County Building Officials have agreed that the guidelines contained in this document provide construction principles and practices that if followed will satisfy the general permit and construction requirements in their jurisdictions. The prescriptive construction methods recommended in this guideline meet or exceed minimum requirements of the 2018 International Residential Code.

This guideline does not contain all of the local jurisdiction requirements for obtaining permits, fees, or procedures for inspection. The guideline also does not prevent the local jurisdiction from asking for additional information or varying from specific requirements based on locally adopted code and ordinance requirements. This guide is not intended to preclude the use of other construction methods and materials which may be approved by the authority having jurisdiction. Prior to beginning any new construction, additions or maintenance work on decks, consult with your local jurisdiction to verify that use of this guideline is acceptable and to familiarize yourself with their specific permit application, plan review and inspection procedures.

This guideline is limited to deck designs using a uniform floor loading of 40 pounds per-square-foot live load and 10 pounds per-square-foot dead load over the entire floor of the deck. Decks supporting loads in excess of the standard uniform loads will require specific approval from the local jurisdiction and may require design by a licensed architect or engineer. Multi-level decks, as well as decks supporting roofs, hot tubs, spas, sun rooms, etc., and decks with cantilevers exceeding code allowances are examples of deck design elements that are not covered by this guideline and will require additional direction from the local jurisdiction.

Where deck ledgers are attached to the dwelling the assumed attachment is over hardboard siding with connection through to the rim joist of the house. Where the exterior consists of other siding materials (stucco, shingles, asbestos siding, etc.) or attachment of the ledger is to brick, concrete, stone, stucco or other materials consult with your local jurisdiction for acceptable attachment methods.

Some tables in this publication are excerpts from the larger tables in the 2018 IRC code book. For more comprehensive information, please refer to the complete tables in the code book.

This is a living document and is subject to change from time to time as codes or other requirements change.

The Johnson County Building Officials Association does not warrant the accuracy, completeness or timeliness of the information contained in this handout. To verify the requirements where you are working, please refer to the official version of the ordinance for the jurisdiction where you are performing work.

Fourth Edition
March 2021

Residential Decks

Permit and Construction Guidelines

Builders and homeowners are required to obtain a permit prior to constructing, altering or replacing a deck.

Plan Submittals

The following information shall be submitted to the building department for their review in order to obtain a deck permit. All the information shown on the sample documents should be contained in all plan submittals. Additional information may be necessary. Plan review fees and permit fees will vary from one jurisdiction to another.

The first requirement is submittal of a **Site Plan**, drawn to scale, for the property where the deck is to be built. Please provide all the information shown on the sample.

Site Plan

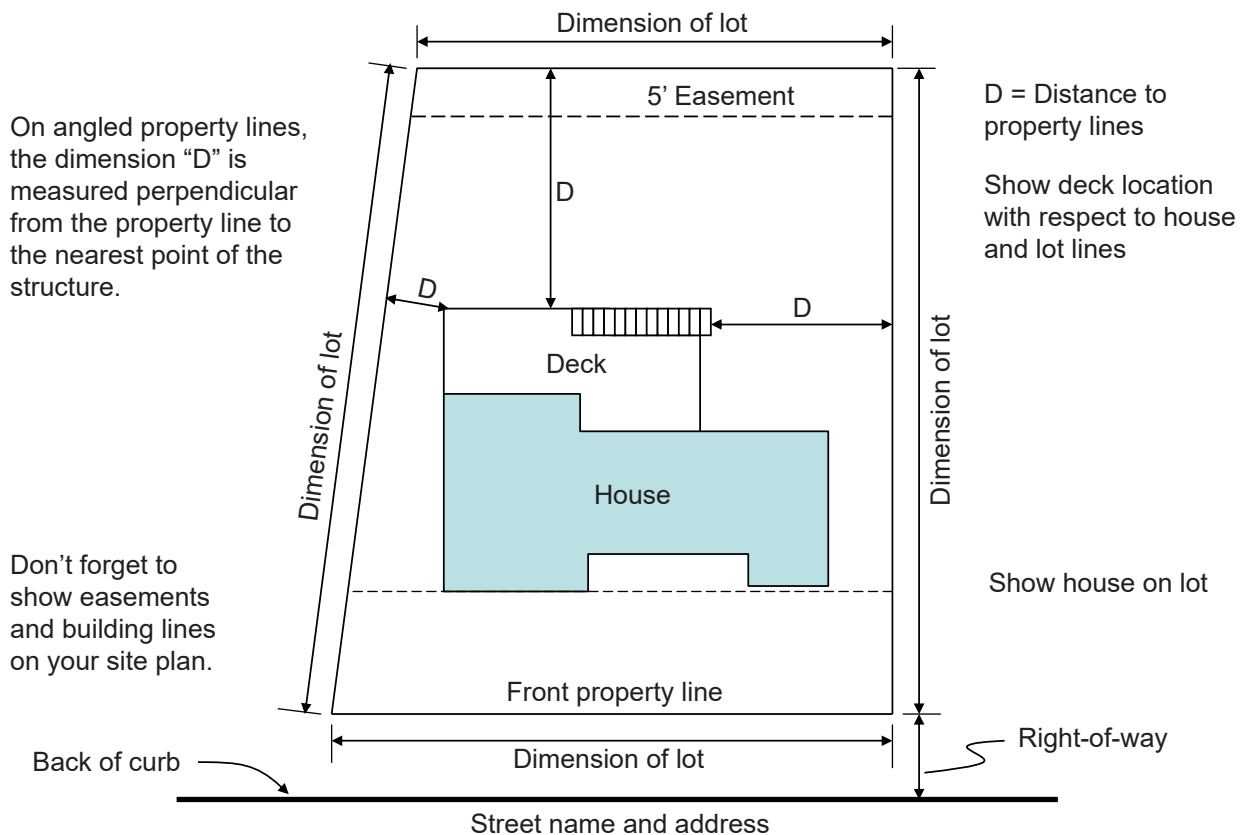

Figure 1

All lot dimensions shall be shown on the Site Plan. The distances to property lines must meet any side and rear yard setback requirements. This Site Plan may be drawn by the builder or the homeowner and does not have to be sealed by a design professional.

The second requirement in obtaining a permit is the submittal of a Deck Plan drawn to scale. This plan should contain as much information as possible about the deck and its construction. The information shown on the sample Deck Plan is the minimal requirement for the plan review process. Additional information may be required by the building department in order to complete their review. This plan may also be drawn by the builder or the homeowner and does not require the seal of a design professional. Some designs and construction methods may, however, require the use of an architect, engineer or other design professional.

Deck Plan

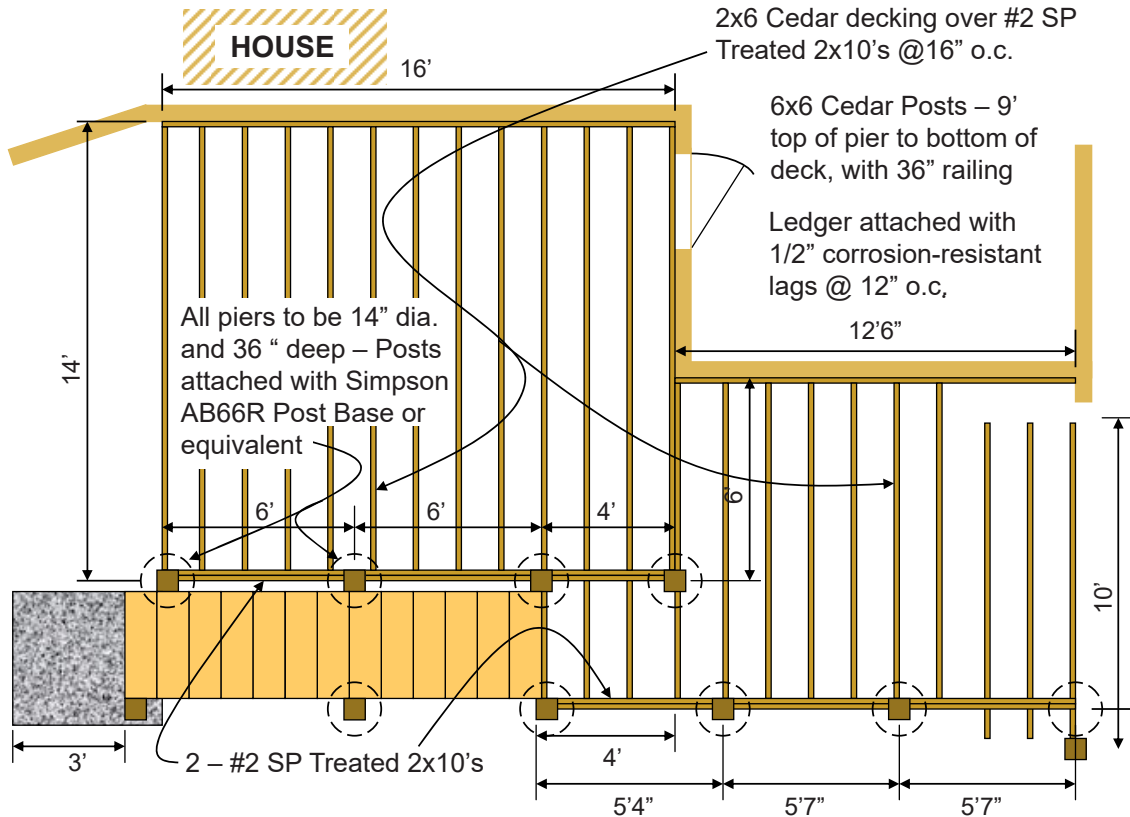

Figure 2

The specific construction information shown on the sample Deck Plan can be found on the tables and diagrams that are provided in this document. Refer to the tables for specific requirements for designing joists, beams, posts, deck piers and connecting the deck to the house. The stair stringers must also be cut and connected properly and must not exceed the spans specified for safety reasons. The information contained in this document should not be considered a complete list of code requirements.

MAXIMUM JOIST SPACING FOR DECKING

A variety of decking materials may be used for the flooring and railings. Please specify the size and type of material and the framing direction, such as '5/4 Radius Edge Cedar Decking running at a 45-degree angle to the floor joists.' This is important because certain products like Radius Edge Decking and composites have

DECKING MATERIAL TYPE AND NOMINAL SIZE	MAXIMUM ON-CENTER JOIST SPACING	
	Decking perpendicular to joist	Decking diagonal to joist ^a
1¼-inch-thick wood	16 inches	12 inches
2-inch-thick wood	24 inches	16 inches
Plastic composite	In accordance with section R.507.2	In accordance with section R.507.2

Based on IRC Table R.507.7

a. Maximum angle of 45 degrees from perpendicular for wood deck boards.

limited span capabilities as shown in Table 1. Composites run perpendicular to joists typically require joist spacing at 16 inches on-center while composites run diagonally typically require joist spacing at 12 inches on-center. Check the manufacturer’s installation instructions for details.

The deck must be constructed of either a naturally decay-resistant lumber or a preservative-treated lumber, and be designed to support a live load of 40 psf. All overhead power lines must be located at least 10 feet above the deck floor or be at least 3 feet horizontally away from the floor surface. An exterior light for the deck and lighting on the stairs is required.

Columns and Piers

The size of the wood columns and concrete piers that are required to support a deck is based on the square footage of deck being supported by that column and pier. This square footage can be determined by using Figure 3 as an example. A column and pier support an area of deck that is half way to the next support in any direction. The house is considered a support. In Figure 3 below, the interior post supports half the joist span going back to the house and half the joist span going toward the outside edge of the deck. Since each set of joists span 8 feet, the post and pier support 4 feet of the span in each direction. That means the interior post and pier is carrying a total of 8 feet parallel to the joists.

Tributary load area for posts

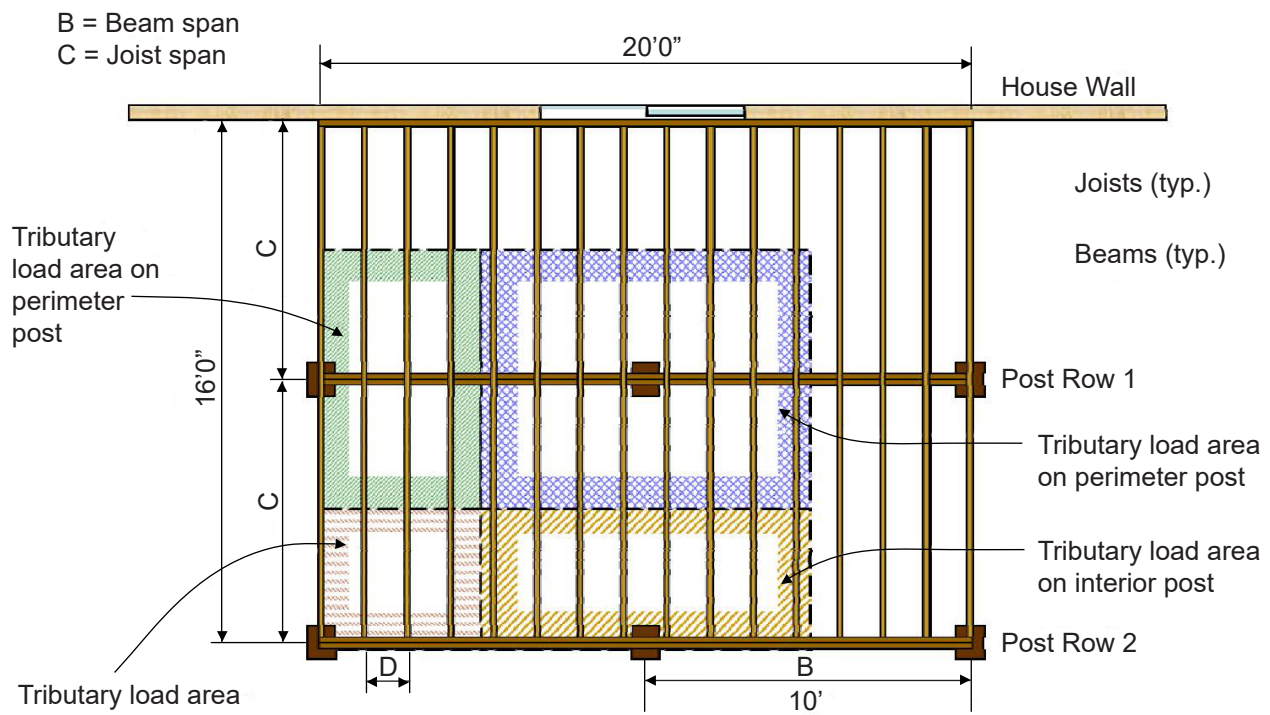

Figure 3

We then determine the distance between posts and piers parallel to the beam. Since the posts are set 10 feet apart in this diagram, the interior post and pier supports 5 feet in both directions for a total of 10 feet along the length of the beam. These two dimensions then give us an area of 80 square feet of

deck supported by the interior post. The perimeter posts carry half the area the interior post carries, or 40 square feet, and the corner posts carry half the area of the perimeter posts, or 20 square feet. Now the size of the columns and the piers can be determined using Tables 2 and 3.

Table 2 on the right shows the size of post that is required to support a deck based on the height of that post. The maximum post height is measured from the top of the concrete pier to the bottom of the beam the post supports. This same post may continue on up to provide support for the guardrail around the deck, but that additional length is not counted as part of the maximum post height.

To use the table, simply find the height of the column that is equal to or less than the height of the deck being built and that will determine the size of the post needed for that application.

A critical part of the deck construction is the concrete pier that supports each post. If they are too small the deck could settle over time and become uneven. To use Table 3, select the square footage of deck supported by the pier. This is the same area that was just determined by using Figure 3. Based on the square footage being supported, select the diameter of the pier required. Remember that all piers are to be a

PIER SIZES BASED ON DECK AREA SUPPORTED

Pier diameter	Square footage of deck that can be supported
8"	10.5
10"	16
12"	24
14"	32
16"	42
18"	53
20"	65
22"	79
24"	94

Based on 1500 psf soil bearing capacity per Table R401.4.1, Presumptive Load-Bearing Values of Foundation Materials

Table 3

DECK POST HEIGHT^a

DECK POST SIZE	MAXIMUM HEIGHT ^{ab} (feet-inches)
4 x 4	6-9 ^c
4 x 6	8
6 x 6	14
8 x 8	14

Based on IRC Table R.507.4

a. Measured to the underside of the beam.

b. Based on 40 psf live load.

c. The maximum permitted height is 8 feet for one-ply and two-ply beams. The maximum permitted height for three-ply beams on post cap is 6 feet 9 inches.

Table 2

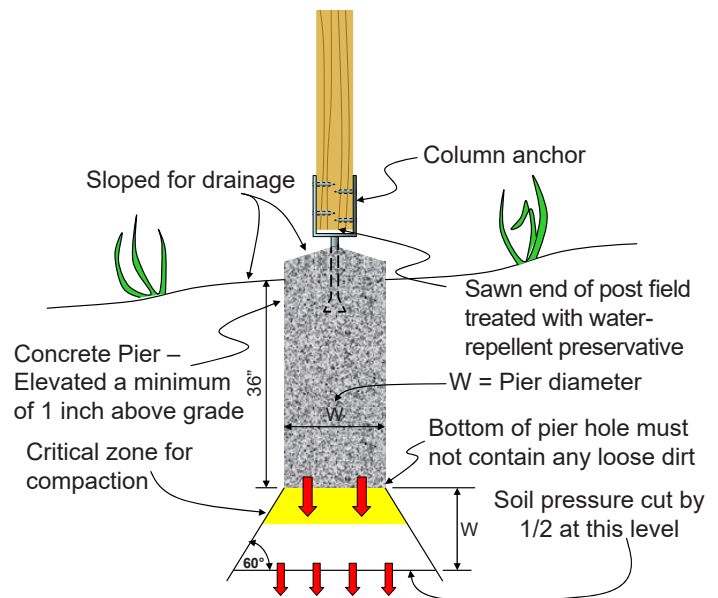

Figure 4

minimum of 36 inches deep to go below the frost line. At least 1-inch of the pier should be elevated above grade with the top sloped for drainage.

Pier sizes can be chosen individually based on the square footage of deck supported by each pier. That would mean each pier might require a different diameter hole. An easier way is to determine the largest diameter hole required and make all the holes that size. This method will, however, require more concrete. Whichever way it is done, this information must be shown on the Deck Plan.

Once the post and pier sizes are determined, a connection must be made between the post and the pier. This connection must resist lateral movement as well as uplift. That means a column anchor must be used to attach the post to the pier. A ‘drift pin’ simply drilled into the bottom of the post is not enough. A 1/2-inch diameter through bolt in both directions drilled into the base of a treated post with the bolts protruding out all four sides, 2 to 3 inches above the bottom, may be cast into a concrete pier as a hold-down. The sample plan states a Simpson AB66R Post Base or equivalent is being used to anchor the post to the pier. Be sure to specify some type of column anchor on the plans. Column anchors are made to fit 4x4 or 6x6 posts. Some column anchors are designed to be set directly in the concrete when it is poured. Others can be drilled into the concrete later, so they can be placed exactly where they need to go after the concrete has set up. Wedge anchors are recommended for these applications.

Ledger to House Connection

Decks are usually supported on one side by a ledger attached to the house. This ledger attachment is critical to insure the deck is safely and securely supported at this point. When the ledger is attached to the house, there are very specific requirements that must be met. Follow the diagrams closely for the proper attachment of the ledger.

The deck ledger shall not be nailed to the house. It must be lagged or bolted to the rim joist of the house which in turn must be securely attached to the framing of the structure and sitting on the foundation wall. Use Table 4 to determine the proper attachment of the deck ledger to the rim joist of the house. The house rim joist may be either a 2-by or a 1-1/4 inch LSL rim for I-joists.

DECK LEDGER CONNECTION TO BAND JOIST
(Deck live load = 40 psf, deck dead load = 10 psf, snow load ≤ 40 psf)

Connection Details	JOIST SPAN						
	6' and less	6'1" to 8'	8'1" to 10'	10'1" to 12"	12'1" to 14'	14'1" to 16'	16'1" to 18"
	On-center spacing of fasteners						
1/2-inch diameter lag screw with 1/2-inch maximum sheathing ^{cd}	30	23	18	15	13	11	10
Equivalent lag spacing for joists @ 16" o.c. (See row above)	Every other joist spaces	Two every third joist space	Each joist space		Each joist space with two every other space		Two in each joist space
1/2-inch diameter bolt with 1/2-inch maximum sheathing ^d	36	36	34	29	24	21	19
1/2-inch diameter bolt with 1-inch maximum sheathing ^e	36	36	29	24	21	18	16

Based on IRC Table R507.9.1.3(1)

c. The tip of the lag screw shall fully extend beyond the inside face of the band joist.

d. Sheathing shall be wood structural panel or solid sawn lumber.

e. Sheathing shall be permitted to be wood structural panel, gypsum board, fiberboard, lumber or foam sheathing. Up to 1/4-inch thickness of stacked washers shall be permitted to substitute for up to 1/2 inch of allowable sheathing thickness where combined with wood structural panel or lumber sheathing.

Table 4

The size and spacing of the lag screws is based on their capacity. Lag screw shear values are assumed to be 230 pounds for 1/2-inch lag screws and 140 pounds for 3/8-inch lag screws. The span of the floor joists determines how much load is being transferred to the ledger and thus to the lag screws. Use Table 4 by picking a lag screw size and then find the span of the floor joists. Under the span will be the required on-center spacing of the lag screws. Since some lag screw spacing will interfere with the framing layout, an equivalent spacing is also provided that may be used in lieu of the specified on-center spacing when the joists are laid out at 16 inches on-center.

Proprietary fasteners such as LedgerLok® may be used in lieu of 1/2-inch lag screws. Other similar type fasteners may also be used but their spacing will depend on their individual lateral design values for single shear connections loaded perpendicular to grain. See Table 5 below for spacing requirements for LedgerLok.®

FASTENING PATTERN FOR ATTACHMENT OF LEDGER TO RIM BOARD USING LEDGERLOK®

Live load	Ledger material	Rim material	Spacing between fasteners (in inches) based on joist spans of:						
			6' or less	Up to 8'	Up to 10'	Up to 12'	Up to 14'	Up to 16'	Up to 18'
40 psf	SYP	2x lumber	24	18	14	12	10	9	8
		EW rim	25	19	15	12	10	9	8

Ledger materials must be a minimum of 2x8 nominal dimensional pressure-preventative-treated No. 2 lumber from any of the following species: Hem-Fir, Douglas Fir or Southern Pine.

Rim joist materials must be either solid sawn 2x lumber or engineered wood specifically designated by the manufacturer as rim material. 2x lumber may be of any species greater than 0.42 specific gravity, including SPF, HF or DF. Engineered Wood (EW) Rim may be OSB, LSL or LVL material measuring 1" or greater in thickness.

Sheathing of 15/32" or 7/16" OSB may separate the ledger and rim but must be attached per code.

The LedgerLok is not designed for attachment to masonry/concrete over stucco, siding, rigid foam insulation or brick veneer.

Table 5

Other proprietary connectors are available. See manufacturer's information for these products.

Pilot holes shall be drilled for lag screws 1/2-inch or larger. The clearance hole for the shank shall have the same diameter as the shank. The lead hole for the threaded portion shall have a diameter equal to 60 percent to 75 percent of the shank diameter. Pilot holes shall not be drilled for 3/8-inch or smaller lag screws. All lags and nails used to connect framing members will be placed at least 2 inches from the ends and edges of the lumber as shown in Figure 5. Do not drive lag screws with a hammer.

The use of lag screws, along with all the other metal connectors used to build a deck, brings us to a very important point. The use of proper fasteners and connections with treated lumber is critical to the overall performance of the structure. Standard carbon-steel nails and fasteners will rust and corrode with time, causing unsightly stains and possibly an eventual failure to hold securely. Therefore, the lag screws or wedge anchors supporting the ledger, and all other connectors used in constructing a deck such as joist hangers and hold downs, must be hot dipped galvanized or stainless steel. Electroplated fasteners are *not* approved for use with treated lumber. Since ACQ and CA treated wood will corrode standard carbon-steel and aluminum, it is of extreme importance that all the connectors and flashings used in deck construction be able to withstand direct contact with these materials.

The new μ CA-C treatment which is a dispersed copper or micronized version is less corrosive than its predecessor. It still requires the use of hot dipped galvanized and G185 galvanized steel fasteners in lieu of standard carbon-steel fasteners, but it does allow the use of coated aluminum flashings.

Check with your supplier to be sure you are getting the proper corrosion resistance on all connecting hardware, such as joist hangers and column anchors as well as lag screws, deck screws and nails.

Figure 5 describes the equivalent spacing of lag screws when joists are spaced at 16 inches on-center. This equivalent spacing described in Table 4 may be used in lieu of the on-center spacing listed.

Many individuals have attached ledgers directly against hardboard siding. This will lead to the eventual deterioration of the siding. Therefore, a 1x3 treated spacer or a plastic donut or galvanized washers shall be placed between the siding and the ledger board to allow for water drainage and for air to get to the siding, so it can stay dry.

The attachment of the 1x3 is made using three 16d hot dipped galvanized nails in a staggered pattern, nailed through the siding and into the rim joist of the house. The lag screws must then go through the 1x3 and into the house rim joist. Note that this attachment requires the lag screw to penetrate the house rim joist and extend at least 1/2-inch beyond. That means this connection requires a minimum 5-inch galvanized lag screw with a standard galvanized washer. Donut type spacers may be used provided they are not more than 1/2-inch thick. See Figure 6.

Deck ledger attachment to house

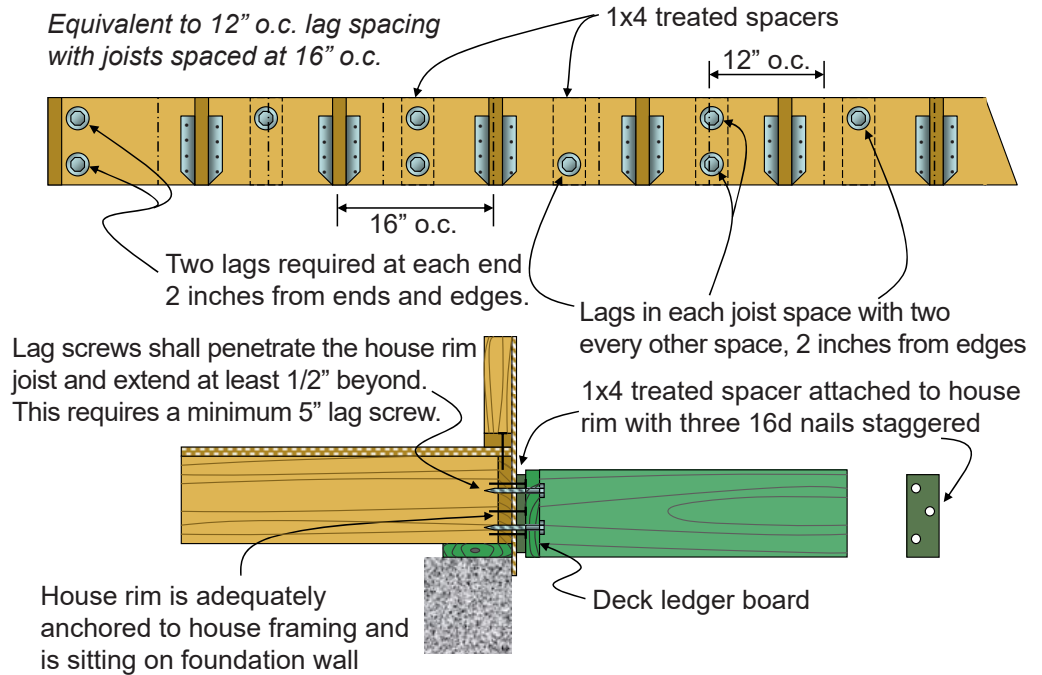

Figure 5

Ledger flashing and connection to house rim

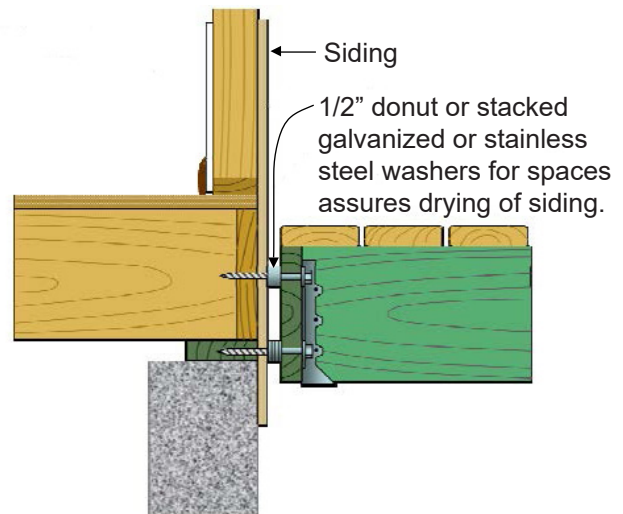

Figure 6

Some builders or homeowners may want to remove the siding and attach the ledger directly to the rim joist of the house. This requires very close attention to flashing details so water cannot get to the house rim and cause structural damage to it and possibly even the ends of the floor joists.

Double flashing of ledger

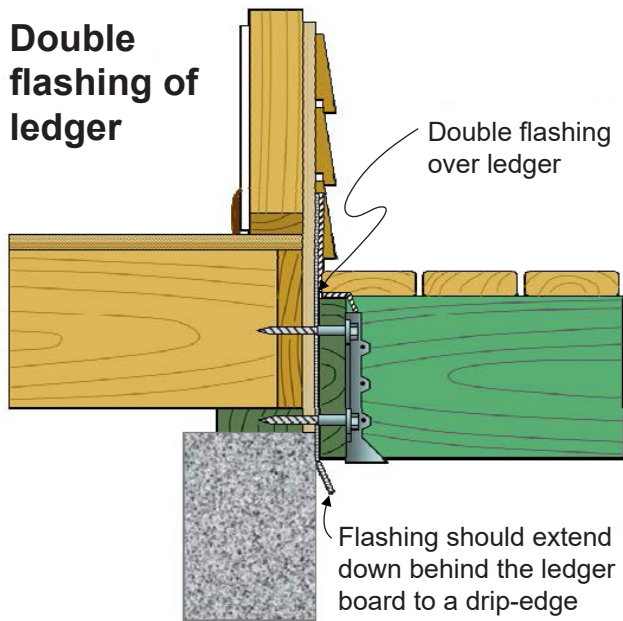

Figure 7

Figure 7 shows that proper flashing extends at least 6 inches up behind the siding and housewrap. The flashing should then extend down past the ledger board and end with a drip-edge at the bottom. To avoid deterioration, the flashing should be galvanized steel, or copper. Aluminum may now be used with the new μ CA-C treatment.

Holes drilled for the lag screws should be caulked before the ledger is applied to prevent water from entering the main structure of the house. A double flashing over the top of the ledger should also be installed. Make sure any overlapping joints in multiple flashing strips are sealed and the ends are run long and bent down so water cannot run in under the flashing and get in the wall behind. See Figure 7.

The house rim joist must be securely anchored to the house framing and it must be sitting on the foundation wall.

Ledger attachment to open web floor trusses

Attaching a ledger to open web floor trusses requires attention to details. The ledger must be attached to the vertical ends of the floor truss member since there is nothing between the floor trusses to attach the ledger to except the sheathing or siding over the trusses and this would not create a satisfactory attachment. Finding the location and spacing of the trusses is very important. Use Tables 6 and 7 to determine how to attach the deck ledger board to floor trusses.

TRUSSES SPACED 16" O.C.			
Deck joist span	LedgerLok or 1/2" lags per truss	Deck joist span	3/8" lags per truss
0–5 ft.	1 every other truss	0–4 ft.	1 every truss
6–7 ft.	1 every truss	5–6 ft.	1 every truss
8–10 ft.	1 every truss	7–8 ft.	1 every truss, 2 every other truss
11–14 ft.	1 every truss, 2 every other truss	9–12 ft.	2 every truss
15–18 ft.	2 every truss	13–18 ft.	2 every truss, 3 every other truss

Table 6

TRUSSES SPACED 16" O.C.			
Deck joist span	LedgerLok or 1/2" lags per truss	Deck joist span	3/8" lags per truss
0–5 ft.	1 every other truss	0–4 ft.	1 every truss
6–7 ft.	1 every truss	5–6 ft.	1 every truss, 2 every other truss
8–10 ft.	1 every truss, 2 every other truss	7–8 ft.	2 every truss
11–14 ft.	2 every truss	9–12 ft.	2 every truss, 3 every other truss
15–18 ft.	2 every truss, 3 every other truss	13–18 ft.	3 every truss

Table 7

Deck ledgers attached to poured concrete walls

When this scenario comes up, then wedge anchors shall be used to attach the ledger board to the concrete wall. See Figure 9. For a 1/2-inch diameter wedge anchor, drill a 1/2-inch hole slightly deeper than the embedment depth, which is 4 inches for this size anchor, and then blow out the dust. Put the washer and nut on before inserting the wedge anchor into the hole. This protects the threads. Tap it in with a hammer and then tighten the nut finger tight. After that, turn it about three to four times with a wrench. Be sure that the wedge anchors are spaced a minimum of ten anchor diameters and that they are five anchor diameters from an unsupported edge.

Deck ledger attachment to concrete

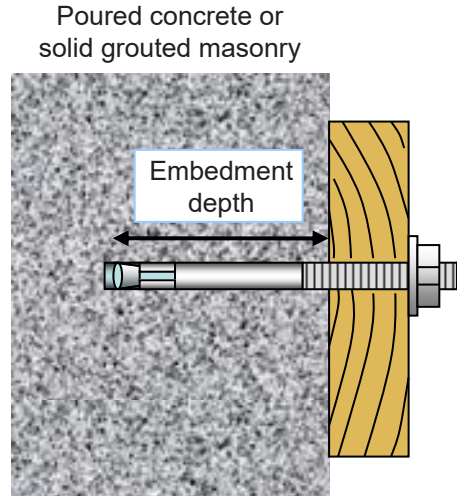

Standard is 10 anchor diameters for spacing between anchors and 5 anchor diameters from any unsupported edge.

Figure 9

Use wedge anchor for attaching ledger board to poured concrete foundation.

For a 1/2" diameter wedge anchor, drill a 1/2" hole with a carbide-tipped masonry bit slightly deeper than the required embedment depth.

Blow out the hole before inserting the wedge anchor.

Put washer and nut on before inserting wedge anchor in hole.

Tighten nut finger tight and then turn it 3 to 4 times with a wrench.

Required size and spacing of hot-dipped galvanized wedge anchors for attaching deck ledger to poured concrete for a given joist span

On-center spacing of wedge anchors (inches)			
Wedge anchor size	Joist span (feet)		
	1/2" dia.	0–7 ft.	8–14 ft.
32" o.c.		24" o.c.	16" o.c.
3/8" dia.	0–6 ft.	7–12 ft.	13–18 ft.
	24" o.c.	16" o.c.	12" o.c.

1/2" wedge anchors shall have an embedment depth of 4"

3/8" wedge anchors shall have an embedment depth of 3"

Thickness of material to be fastened, plus the embedment depth, plus the thickness of the nut and washer equals minimum wedge anchor length.

The forces on a Wedge Anchor are transferred to the base material in which it is installed. If the anchors are installed too close together, it can cause an interaction of the forces, thus reducing the holding power of the anchor. As a rule of thumb, the expansion industry has established a minimum standard of ten (10) anchor diameters for spacing between anchors and five (5) anchor diameters from any unsupported edge. When vibration or sudden impact are part of the load conditions, spacing between anchors should be increased.

Table 8

Deck ledgers shall not be attached to or through exterior veneers such as brick, masonry, stone or stucco

These veneers are non-structural and will not support the vertical or lateral loads imposed by the deck on the exterior wall of the structure. Even attaching through the veneer to the wood framing behind is not acceptable because the connector is now cantilevered and is not designed to support such loads in this type of an application. The connectors supporting the deck shall not be cantilevered more than one-half-inch. Build a free-standing deck instead.

Ledger cannot be attached to brick or stone

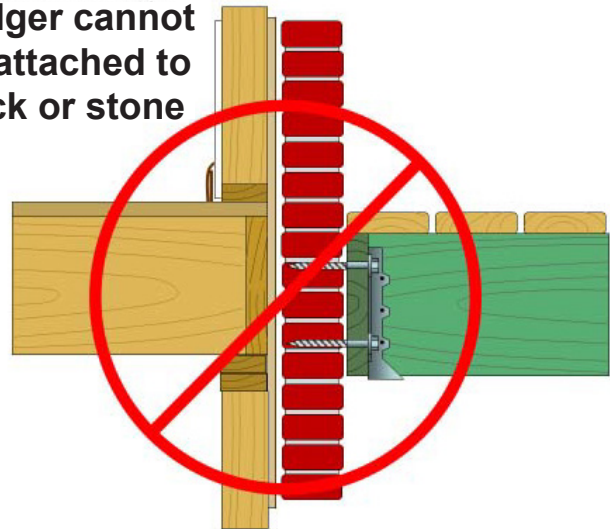

Figure 10

Deck ledger shall not be attached to a cantilevered portion of the building

Ledgers shall not be attached to cantilevers unless the connection is engineered, or the following prescriptive method is followed. Note there are limitations imposed on this prescriptive method. Be sure to follow all the details very closely.

Prescriptive method for attaching a deck ledger to a cantilever.

In order to attach a deck to a cantilevered portion of a house, it is critical that the rim joist be able to carry the added load of the deck in addition to the weight of the exterior wall which is already sitting on it. Since the rim joist is only nailed into the ends of the floor joists, that connection is not sufficient to support the extra load imposed on it by a deck. This is especially true with wood-I joists which only have two nails connecting the rim to each wood-I joist.

The first requirement for attaching a deck to a cantilever is the house joists must be 2x10's or wood-I joists spaced at 16 inches on-center. Each 2x10 joist must then be doubled with an additional 6- foot No. 3, Doug Fir, 2x10 nailed together with 10d common nails at 16 inches on-center staggered.

Wood-I joists must also be doubled with 30-inch long web stiffeners added. The web stiffeners shall be placed between the I-joists and on the outside flanges of each of the two I-joists and nailed together with a row of 4 – 10d nails every 16 inches. The original joists and the added joists will each be toe-nailed to the sill plate with 3 – 8d nails. Solid blocking between the 2x10 joists or wood-I's shall be provided over the foundation wall.

The next thing that must be done is to attach the rim joist to the doubled floor joists with Simpson LS90 gusset angles or their equivalent. These angles are designed to transfer the load imposed on the rim by the deck back into the doubled joists. Each of these gusset angles shall be nailed on with 12 – N10 nails, six nails into the rim and the other six into the doubled joists.

The maximum deck joist span for this application is 16 feet. This maximum span would require two 1/2-inch lag screws between each deck joist if they are laid out at 16 inches on-center. Figures 11 and 12 show section and plan views detailing how a deck ledger shall be attached to a cantilevered floor system.

Attaching deck to cantilevered floor joists

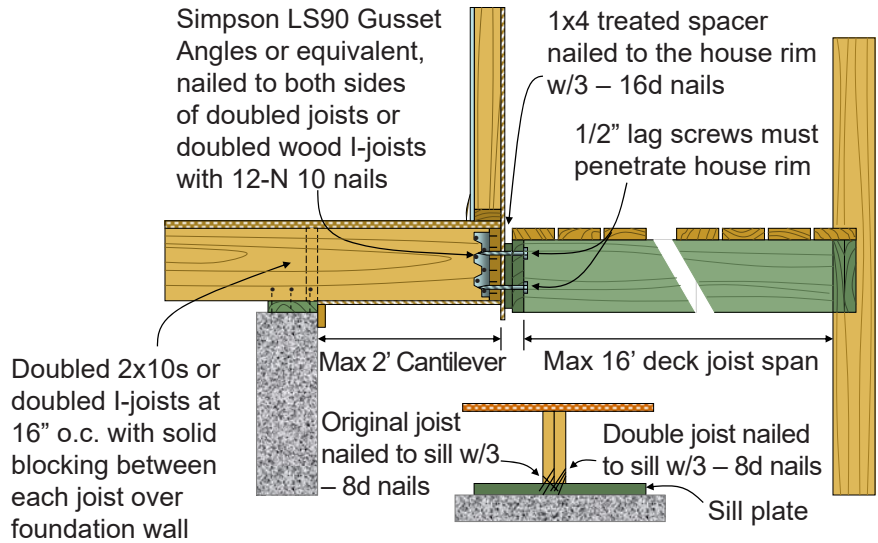

Figure 11

Attaching deck to cantilevered floor joists

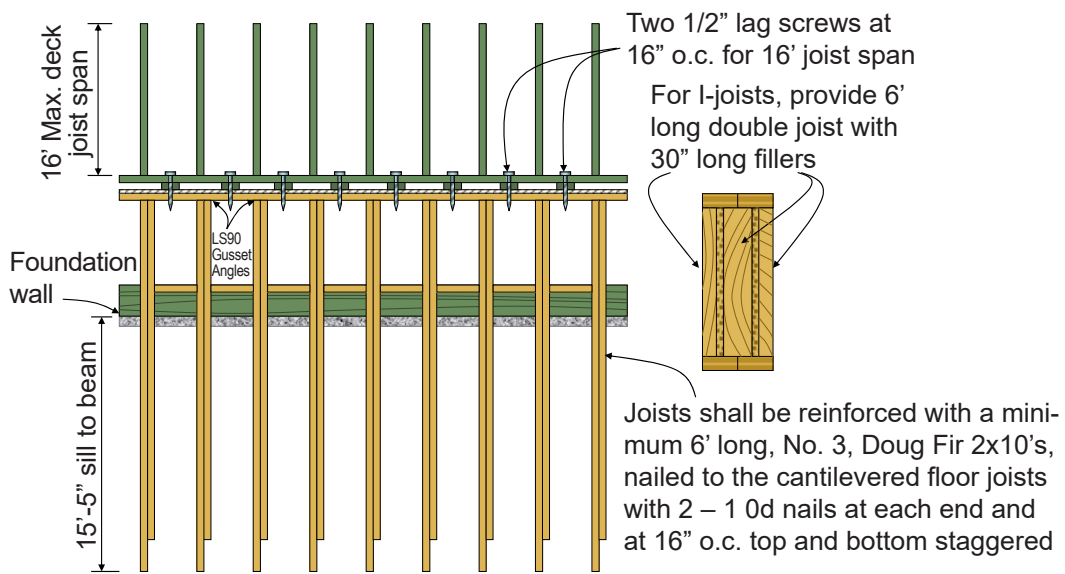

Figure 12

Headering off a cantilever

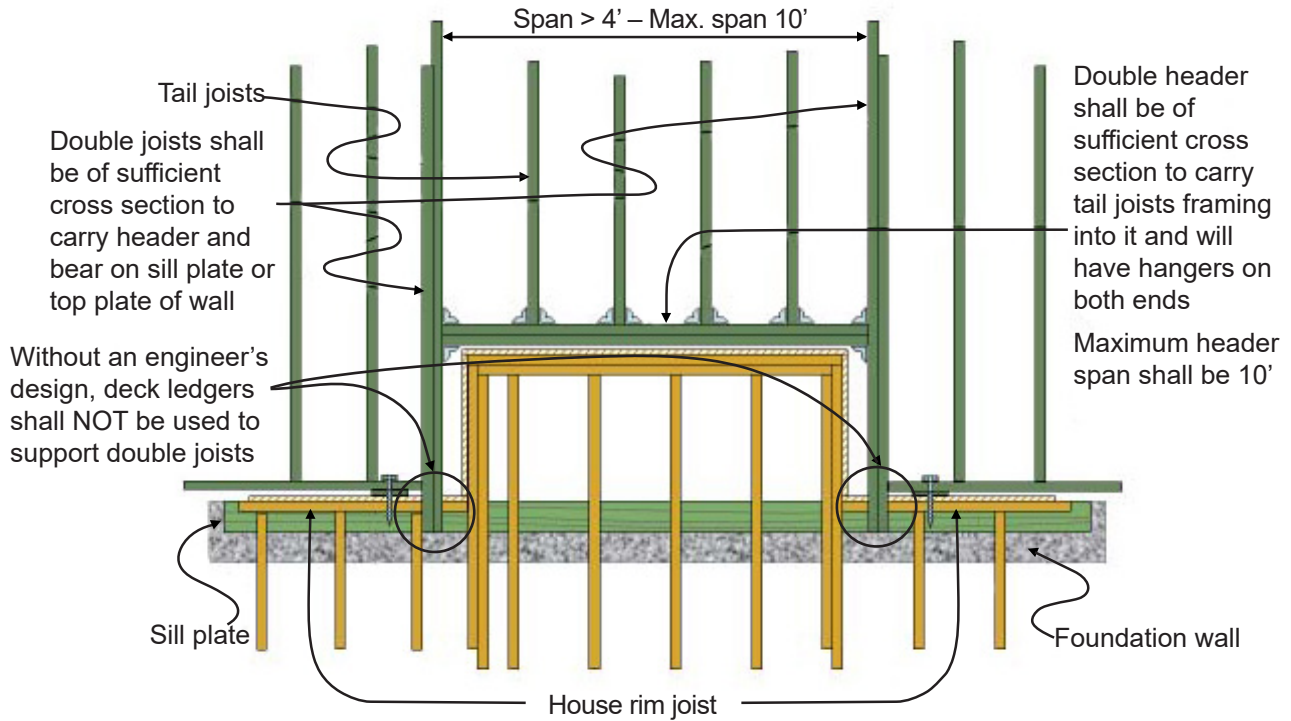

Figure 13

Framing around a chimney or bay window which extends beyond the exterior wall of the house may be accomplished by headering across the chimney or bay window area with a double header attached to double joists on each side. The double joists shall bear on top of the foundation wall. Doubling of these members is required when the header span is greater than 4 feet. The double joists and header shall be of sufficient cross section to carry the tail joists framing into the header. The maximum header span shall be 10 feet.

The header shall be supported on each end by a double hanger when the header span exceeds 6 feet. Tail joists over 12 feet long shall be supported at the header by joist hangers. An air space shall be provided between the double header members and the house to allow for water drainage and air circulation.

Joist and Beam Spans

Floor joists and beams have certain span capabilities based on the size, grade, species and spacing of the material used for the joists or beams and the loads that are imposed on them. Deck joists are required to be designed for 40 pounds per-square-foot live load, just like a residential floor. Most joist material used for building decks is No. 2 and better, treated Southern Pine.

DECK JOIST SPANS FOR COMMON LUMBER SPECIES (ft.-in.)

SPECIES	SIZE	ALLOWABLE JOIST SPAN		
		SPACING OF DECK JOISTS (inches)		
		12	16	24
Southern pine	2 x 6	9-11	9-0	7-7
	2 x 8	13-1	11-10	9-8
	2 x 10	16-2	14-0	11-5
	2 x 12	18-0	16-6	13-6

Based on IRC Table R507.6

See 2018 IRC for complete span table

No. 2 grade minimum

Table 9

To find the span capabilities for the deck joists, find the size of material being used and the on-center spacing. Where the two intersect is the appropriate span for that material. Joist spans are measured from unsupported edge to unsupported edge plus half the required bearing at each end. See Figure 14 for a visual representation of how a joist span is measured.

Remember that the ends of the joists will need to be properly supported. If they are running between the ledger and a beam, they will need joist hangers on both ends. The typical double shear joist hangers shall be attached with full 10d galvanized nails that are 3 inches long into the toe-nailed connections on the side of the hanger. **Screws shall not be used to support joist hangers or in hold downs unless the screws are supplied by the hanger manufacture and designed for that application.**

Joist span measurement and beam to post connection

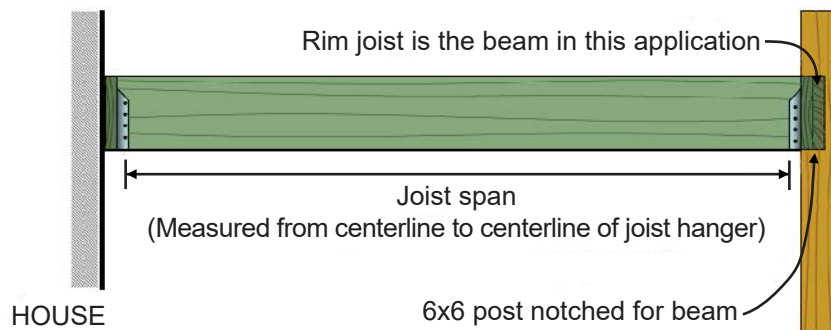

Figure 14

Calculating the beam span is directly related to the joist spans. Table 10 lists the maximum allowable spans for a variety of different sized beams upon the joist span. The beam may be cantilevered to a maximum of 1/4 of the allowable beam span.

DECK BEAM SPAN LENGTHS^{a, b, g} (feet-inches)

SPECIES ^c	SIZE ^d	DECK JOIST SPAN LESS THAN OR EQUAL TO (feet)						
		6	8	10	12	14	16	18
Southern pine	1 – 2 x 6	4-11	4-0	3-7	3-3	3-0	2-10	2-8
	1 – 2 x 8	5-11	5-1	4-7	4-2	2-10	3-7	3-5
	1 – 2 x 10	7-0	6-0	5-5	4-11	4-7	4-3	4-0
	1 – 2 x 12	8-3	7-1	6-4	5-10	5-5	5-0	4-9
	2 – 2 x 6	6-11	5-11	5-4	4-10	4-6	4-3	4-0
	2 – 2 x 8	8-9	7-7	6-9	6-2	5-9	5-4	5-0
	2 – 2 x 10	10-4	9-0	8-0	7-4	6-9	6-4	6-0
	2 – 2 x 12	12-2	10-7	9-5	8-7	8-0	7-6	7-0
	3 – 2 x 6	8-2	7-5	6-8	6-1	5-8	5-3	5-0
	3 – 2 x 8	10-10	9-6	8-6	7-9	7-2	6-8	6-4
	3 – 2 x 10	13-0	11-3	10-0	9-2	8-6	7-11	7-6
3 – 2 x 12	15-3	13-3	11-10	10-9	10-0	9-4	8-10	
Douglas fir-larch ^e , hem-fir ^e , spruce-pine-fir ^e , redwood, western cedars, ponderosa pine ^f , red pine ^f	3 x 6 or 2 – 2 x 6	5-5	4-8	4-2	3-10	3-6	3-1	2-9
	3 x 8 or 2 – 2 x 8	6-10	5-11	5-4	4-10	4-6	4-1	3-8
	3 x 10 or 2 – 2 x 10	8-4	7-3	6-6	5-11	5-6	5-1	4-8
	3 x 12 or 2 – 2 x 12	9-8	8-5	7-6	6-10	6-4	5-11	5-7
	4 x 6	6-5	5-6	4-11	4-6	4-2	3-11	3-8
	4 x 8	8-5	7-3	6-6	5-11	5-6	5-2	4-10
	4 x 10	9-11	8-7	7-8	7-0	6-6	6-1	5-8
	4 x 12	11-5	9-11	8-10	8-1	7-6	7-0	6-7
	3 – 2 x 6	7-4	6-8	6-0	5-6	5-1	4-9	4-6
	3 – 2 x 8	9-8	8-6	7-7	6-11	6-5	6-0	5-8
	3 – 2 x 10	12-0	10-5	9-4	8-6	7-10	7-4	6-11
	3 – 2 x 12	13-11	12-1	10-9	9-10	9-1	8-6	8-1

Based on IRC Table R507.5

For SI: 1 inch = 24.4 mm, 1 foot = 304.8 mm, 1 pound per square foot = 0.0429 kPa, 1 pound = 0.454 kg.

- a. Ground snow load, live load = 40 psf, dead load = 10 psf, L/Δ = 360 at main span, L/Δ = 180 at cantilever with a 220-pound point load applied at the end.
- b. Beams supporting deck joists from one side only.
- c. No. 2 grade, wet service factor
- d. Beam depth shall be greater than or equal to depth of joists with a flush beam connection.
- e. Includes incising factor.
- f. Northern species: incising factor not included.
- g. Beam cantilevers are limited to the adjacent beam's span divided by 4.

Table 10

When multiple members are used, they must be attached so they act as one. This requires nailing the members together with two rows of 10d nails at 16 inches on-center staggered.

If a single Cedar 4x10 were going to be used instead of a built-up treated beam, then Table 10 would be used. In the case of our 7-foot tributary width, (a 14- foot joist span), a 4x10 has a span capability of 6 feet, 6 inches.

By the way, 2 – 2x10's are not the same as one 4x10. They have a different cross-sectional area, for one thing.

Note that 6x6 posts are designed to be used in vertical applications and should not be used as a beam in a horizontal application. Only rectangular members that are more than 2 inches out of square should be used for beams. For example, a 6x10 is more than 2 inches out of square. A beam should always be supported directly by the columns beneath it. This is usually accomplished by notching the beam into the posts so there is direct wood to wood bearing. Note, 6x6 posts are required if a double 2-by beam is to be notched into the posts. If the beam is notched into opposite sides of a 6x6 post the two members shall be solidly blocked between the two beam members every 4 feet so they may be securely nailed together in order for them to act as one unit.

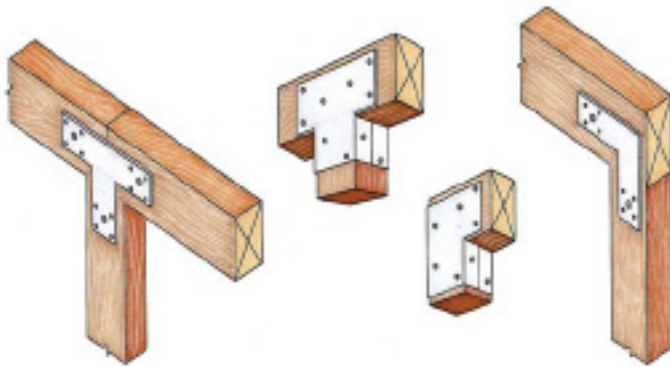

POST-TO GIRDER CONNECTIONS

Figure 15

However, there are times when a beam must sit on top of a post. In these cases, there must be a positive connection between the post and the beam. Sometimes a 2-by scabbed on the sides connecting the beam to the column is sufficient, but metal connectors are also available. See Figure 15 for different ways to connect beams to posts.

It should be noted that engineered lumber beams are now available with preservative treatment for exterior applications. The products are somewhat limited at this time but one such product is Parallam®, Parallel Strand Lumber (PSL). See the manufacturer's specifications

for design tables and construction details. Preservative treated Glulams are also available. These glulam beams are treated with a Copper Naphthenate (CuN) at 0.04 pcf. Glulam beams treated to this retention level shall be used in above ground applications only. There are also glulam columns that are treated with CuN at a retention level of 0.13 pcf which can be used in ground contact applications.

Note that beam spans are measured similar joist spans.

A beam span is measured from the center of support to the center of support. Also notice that a beam may only be cantilevered a maximum of the adjacent beam's span divided by 4. If the beam is not notched into the post, then the structural performance of the connection is limited to the capacity of the bolts which typically connect the beam members to the post. Bolting the beam members to the side of the 6x6 column is not an acceptable connection and is not allowed. Notching the beam into a 6x6 post or sitting the beam directly on top of the post allows direct wood to wood bearing, and this will always provide proper support.

Bolting beam to post is not allowed

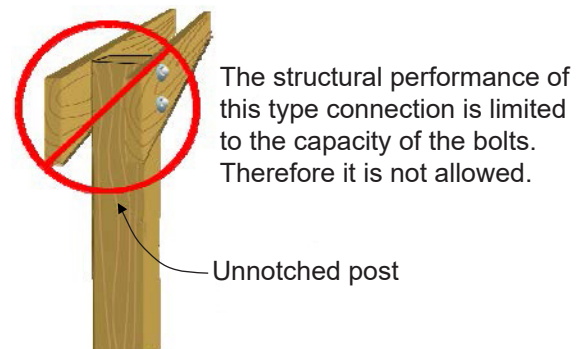

Figure 16

Cantilevered Decks

It is often desirable to cantilever a deck for aesthetics or for other reasons. Certain considerations must be taken into account when using a cantilever. The maximum joists cantilever shall be limited to one-fourth of the joist span or the maximum cantilever length specified in Table 11, whichever is less. The back span for a cantilever must be a minimum of twice the cantilevered distance. A concentrated load on the end of the cantilever has the effect of producing uplift on the joists at the first interior beam support or at the attachment to the house. When a deck is cantilevered, the connection to the exterior wall of the house or other framing members such as a beam shall be designed and constructed to resist uplift resulting from the full live load acting on the cantilevered portion of the deck. One way of resisting these loads is with a steel twist strap such as a Simpson H2.5A to prevent uplift.

Deck Stability

Free standing decks greater than 2 feet above grade shall resist lateral loading and horizontal movement by providing diagonal bracing or by attaching to the exterior wall of the house.

The bracing shall be placed at a 45-degree angle and bolted to the post at one end and the beam at the other. When the post and beam do not align with the bracing location, provide blocking between the brace and the adjacent member.

Another way to brace a deck for lateral stability is to use diagonal steel strapping or 1x4 treated boards run in an 'X' fashion across the joists from corner to corner. CS16 galvanized coiled strapping works nicely.

MAXIMUM CANTILEVER

SPECIES	SIZE	MAXIMUM CANTILEVER		
		SPACING OF DECK JOISTS WITH CANTILEVERS (inches)		
		12	16	24
Southern pine	2 x 6	1-3	1-4	1-6
	2 x 8	2-1	2-3	2-5
	2 x 10	3-4	3-6	2-10
	2 x 12	4-6	4-2	3-4

Based on IRC Table R507.6. See 2018 IRC for complete span table.

a. No. 2 grade with wet service factor.

c. Ground snow load, live load – 40 psf, dead load – 10psf, L/Δ – 360 at main span, L/Δ – 180 at cantilever with a 220-pound point load applied to end.

f. Cantilevered spans not exceeding the nominal depth of the joist are permitted.

Table 11

Measuring a beam span

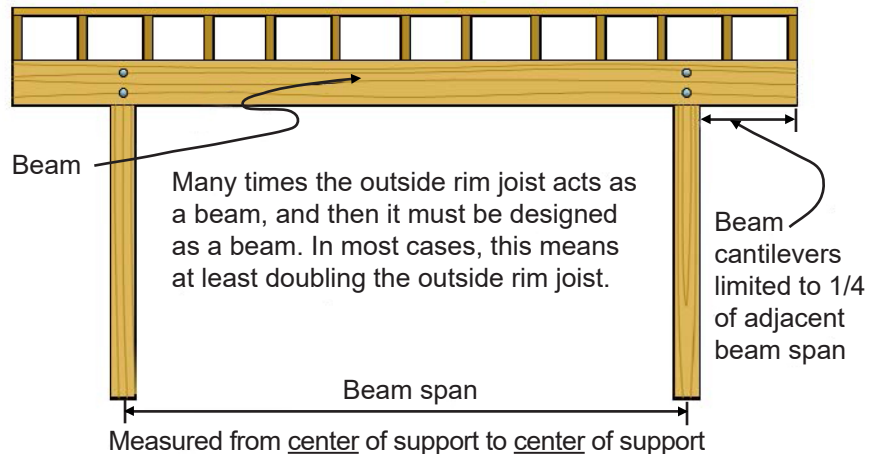

Figure 17

Cantilevered joist detail

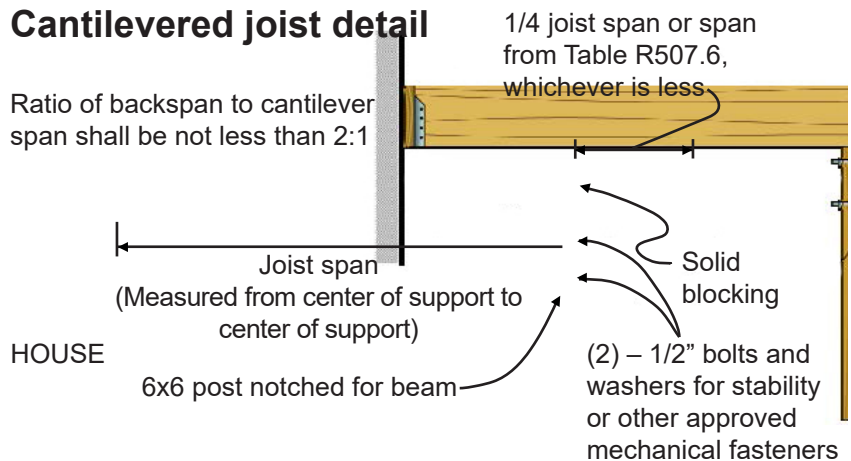

Figure 18

Cantilevered connection

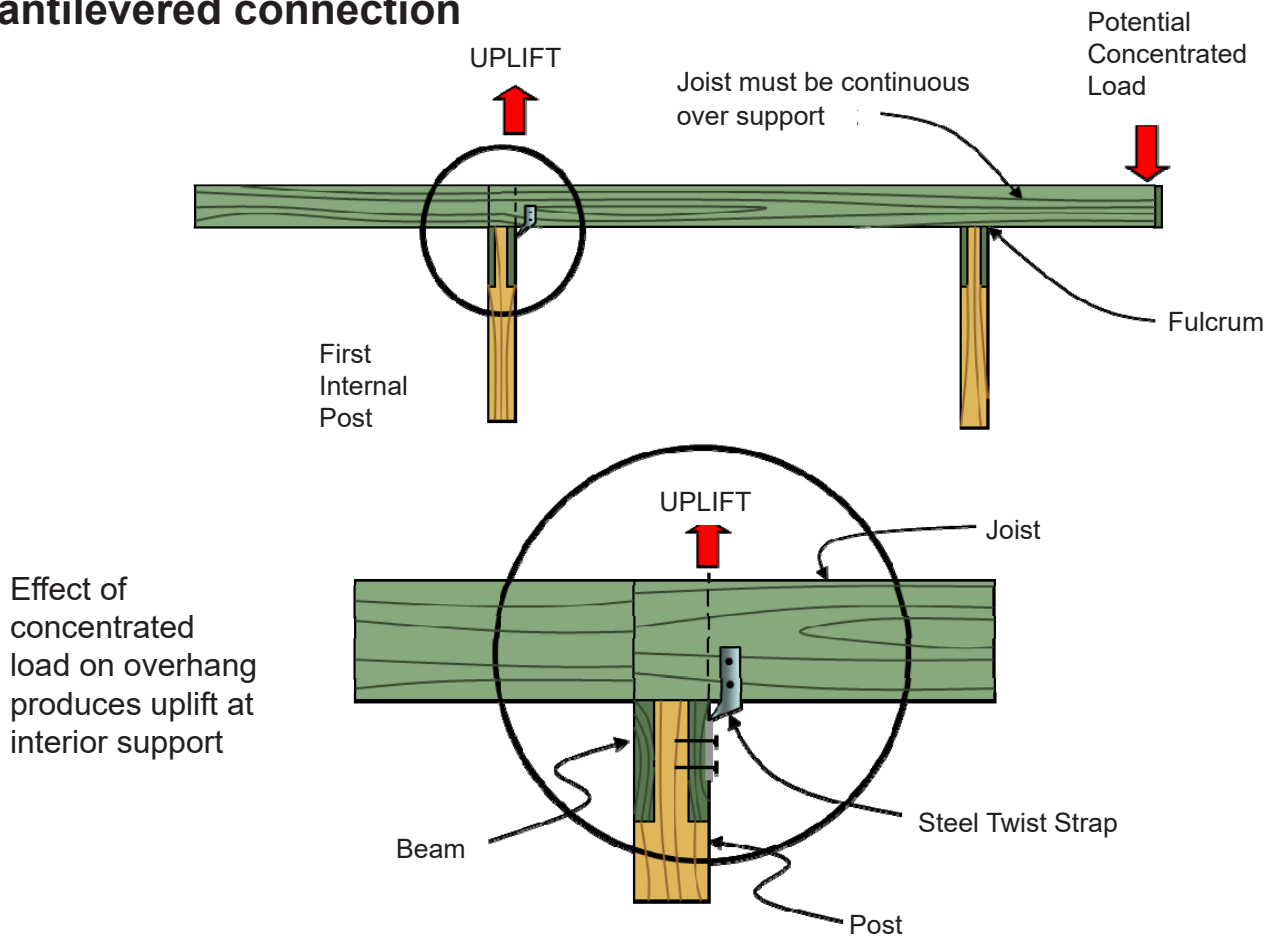

Figure 19

Guards

For obvious safety reasons, guards are required when the deck floor is more than 30 inches above another floor or the grade below. That measurement is taken vertically to the floor or grade below at any point within 36 inches horizontally to the edge of the open side. The guard shall not be less than 36 inches in height. Insect screening shall not be considered as a guard.

Open sides of stairs with a total rise of more than 30 inches above the floor or grade below shall have guards not less than 34 inches in height measured vertically from the nosing of the treads. The triangular opening formed by the riser, tread and bottom rail of the guard at the open sides of a stairway is permitted to be of such a size that a 6 inches diameter sphere cannot pass through. If the deck is less than 30 inches above grade, no guard is required on either the deck or the stairs.

LATERAL SUPPORT OF OUTSIDE END OF DECKS

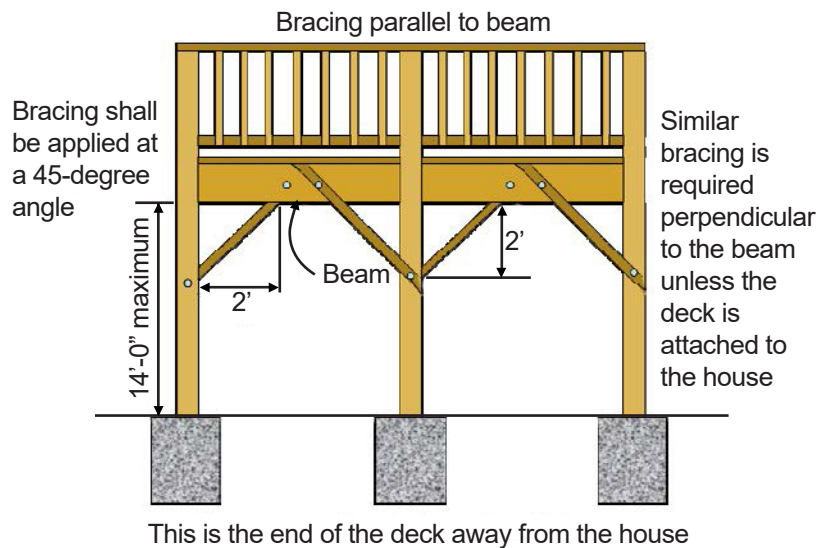

Figure 20

Deck bracing with diagonal straps across top of joists

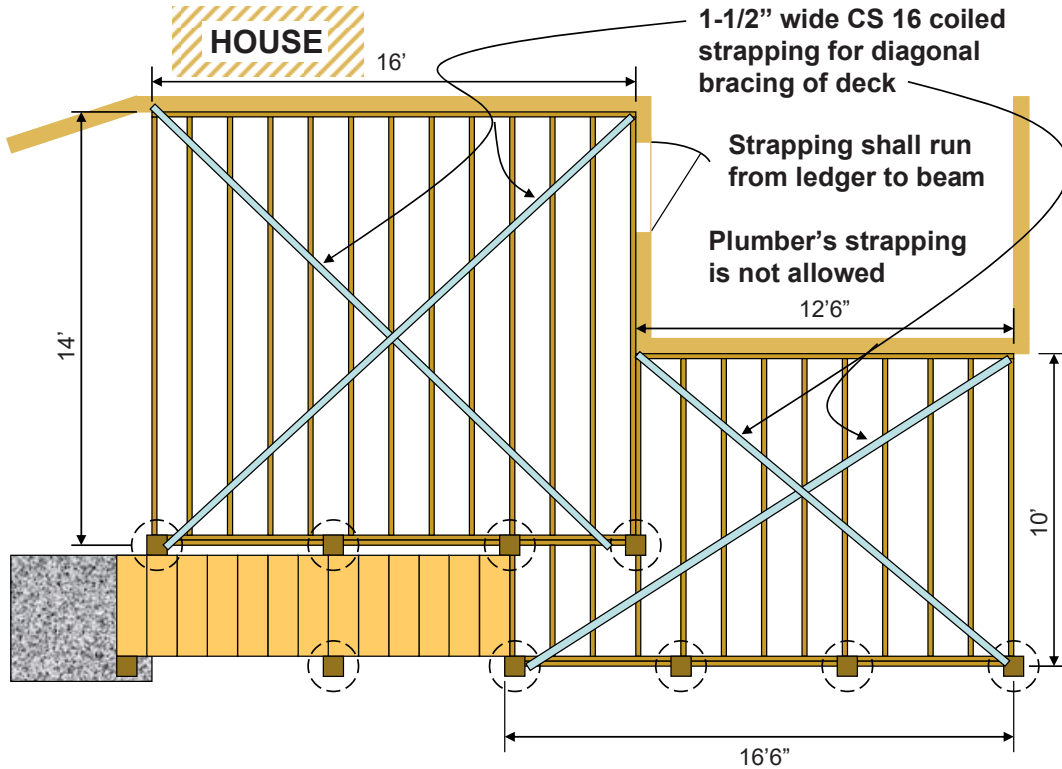

Figure 21

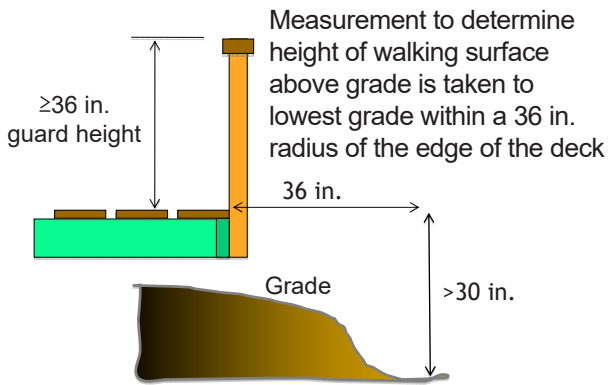

Figure 22

The perimeter support posts can be incorporated into the railing of the deck. The posts can extend from the footings to the top rail cap. Balusters or ornamental closures that do not allow a 4-inch diameter sphere to pass through are used to fill in-between the posts. These balusters in combination with the cap rail and bottom rail transfer the loads to the posts. In order to do this successfully, the main railing posts should be spaced approximately 6 feet apart. The advantage of this design is that the full length of the post resists the rail load.

Guards and handrails shall be designed to support a single 200-pound concentrated load applied in any direction at any point along the top. This is to be sure the railing can support the loads of people leaning on or running into it.

The guard in-fill components which consist of the balusters or panel fillers shall be designed to withstand a horizontally applied normal load of 50 pounds distributed over a one square foot area.

Guard detail

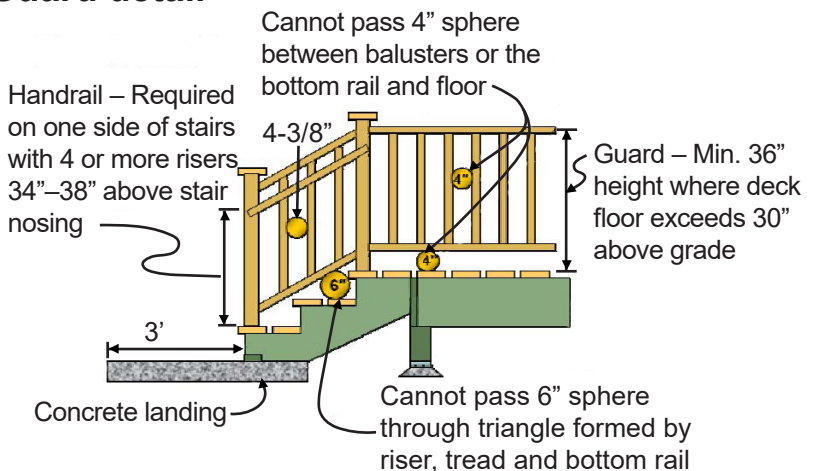
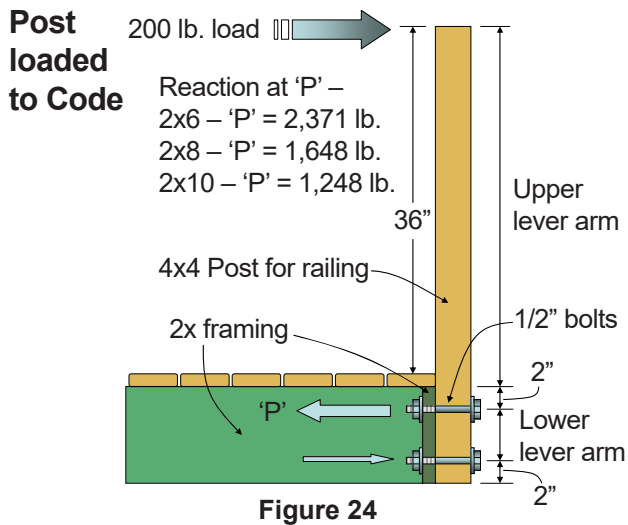

Figure 23



When guard posts are not a continuous part of the support post system, they must be attached so they can withstand the prescribed loads without hinging or twisting the rim joist. It is therefore necessary to be sure the rim joist is blocked so it cannot rotate. Lag screws into the ends of the perpendicular joists or blocking are the proper connectors for this purpose. Nails into the end grain of the framing lumber will simply withdraw allowing the rim joist to twist.

Figure 24 shows the reaction load that is imposed on the top bolt in various size rim joists when the code prescribed load is applied.

Figure 25 shows a plan view of the connection details for attaching the guard posts to the rim joist and the rim joist to the deck joists. Two lag screws in the deck joists or blocks on each side of the post are necessary to prevent the rim from rotating unless the post is blocked in from behind and lagged to a joist perpendicular to the rim joist. Use 1/2-inch diameter bolts when attaching 4x4 railing posts to the rim joist so it cannot work loose over time. This is especially true when the posts are being attached to the outside edge of the rim.

Reinforced Post Connections
(Plan view)

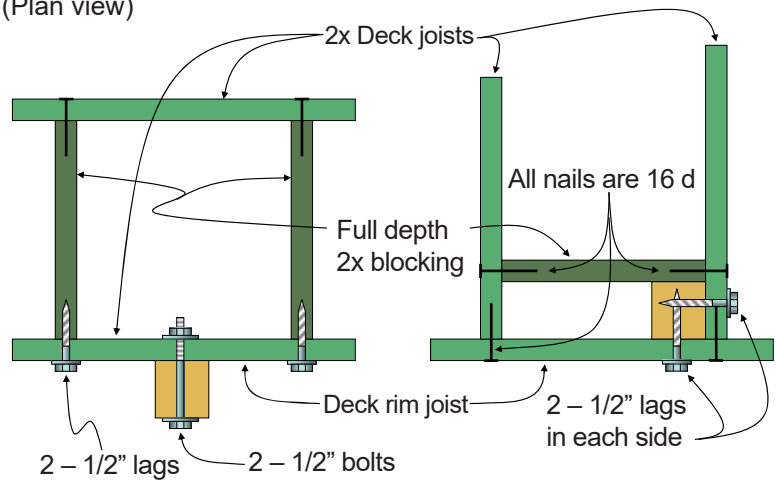
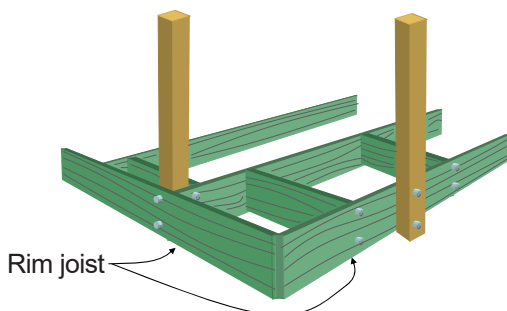

Figure 25

Reinforced Post Connections
(Three dimensional view)



The leverage from a deck railing post will twist the rim joist unless the rim joist is securely fastened to the joist ends or perpendicular blocking. 1/2" lag screws are recommended for resisting code design loads.

Figure 26

An extremely strong way to attach the railing posts, especially if they are to be installed on the outside of the rim joist, is to use a hold-down tension device on the top bolt to resist the tremendously high outward force at that point. This same device can also be used even if the post is installed on the inside of the rim joist. This connection will assure that the post will never loosen up over time from lateral loads acting against the top rail.

Stairs

Stairways shall have a minimum width of 36 inches. The maximum riser height shall be 7-3/4 inches and the minimum tread depth shall be 10 inches as measured in Figure 28. Open risers are permitted provided the opening between the treads does not allow the passage of a 4-inch diameter sphere. The opening between adjacent treads is not limited on stairs with a total rise of 30 inches or less. The greatest riser height and tread depth within any flight of stairs shall not exceed the smallest by more than 3/8-inch.

There shall be a minimum of two stringers where the spacing between them is 24 inches. This requires treads of 2-by dimension lumber to overhang 5 inches beyond each stringer. Three stringers may be used where the outside members are placed 36 inches apart and a third is centered in between. Now the 2-by treads are supported on the ends and in the center. This gives us a stronger set of stairs and allows us to meet the 300-pound concentrated load requirements.

Composite decking and 5/4 wood decking can typically only span 16 inches on-center. That means stringers need to be 16 inches on-center for these materials. Check with the composite manufacturer for stair stringer spacing. Some composites can only span 8 inches on-center when used as stair treads.

The stair stringers shall be 2x12, No. 2, treated Southern Pine. They must not be over notched when cutting in the rise and run. The cuts in these notches must end at the inside corners and not extend beyond that corner or the stringers will be weakened.

The top of each stringer shall be toe-nailed to a backer or rim joist and then supported by Simpson LS70 gusset angles or their equivalent on one side of each stringer. An alternate method would be to use sloped hangers. Simpson now has an LSCZ adjustable stair stringer connector which can be used in this application.

Post Connections that Resist 200 lbs. Lateral Load

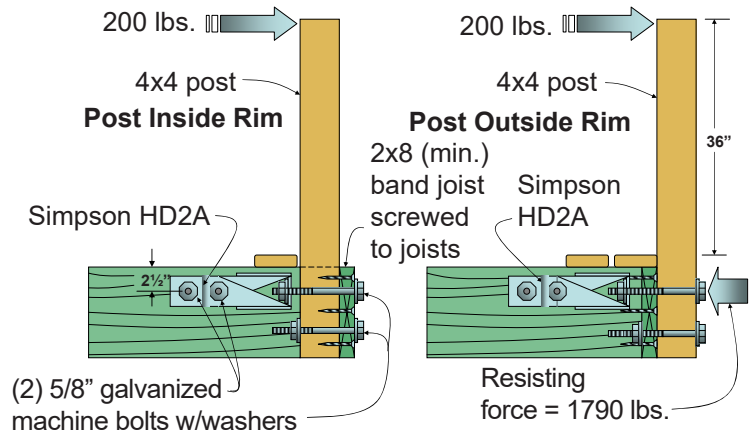
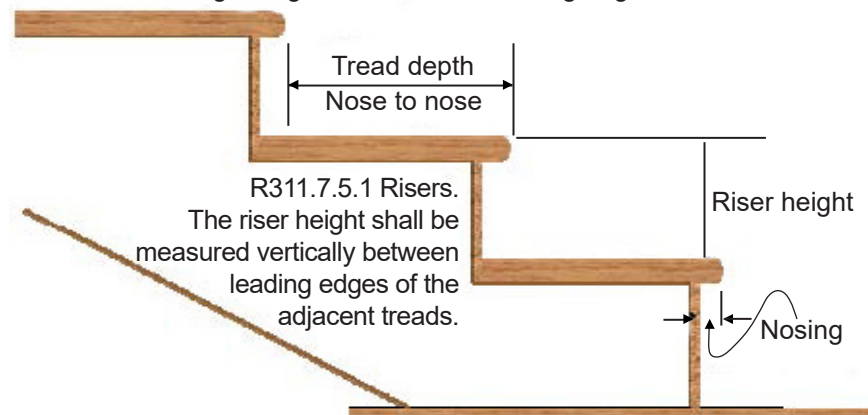

Figure 27

Stair Measurements

R311.7.5.2 Treads. The tread depth shall be measured horizontally between the vertical pieces of the foremost projection of the adjacent treads and at a right angle to the tread's leading edge.



R311.7.5.3 Nosings. Nosings at treads, landings and floors of stairways shall have a radius of curvature at the nosing no greater than 9/16 inch or bevel not greater than 1/2 inch. A nosing projection not less than 3/4 inch but not more than 1 1/4 inches shall be provided on stairways.

Figure 28

The bottom of these stringers shall rest on a landing. It is recommended that this landing be concrete, but a level, hard, flat surface that won't erode away is all that is required. Flagstones, patio blocks or other flat stones could be used. The bottom of the stringers could then be notched over a treated 2x4 sleeper which could be attached to the landing or the stringers could be notched in behind the hard landing itself. Either way effectively locks the stringers in place.

Stair Stringer Detail

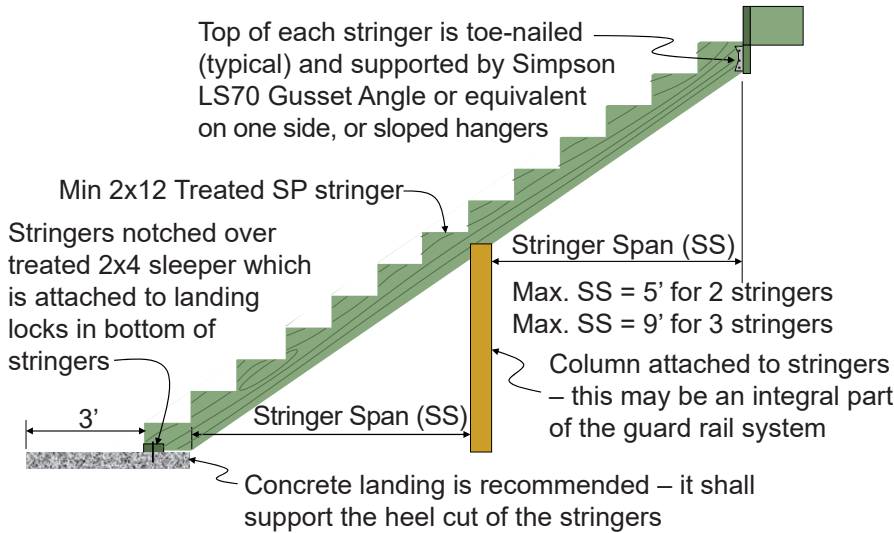

Figure 29

The stringers also have a certain span capability. When using 2 stringers to support the stairway, the maximum span for the stringers is 5 feet. When using 3 stringers the maximum span is increased to 9 feet. The span is measured horizontally from point of support to point of support. See Figure 29.

The stringers are spaced and supported in this manner so the treads can meet the 300-pound concentrated load requirement. If the same material that is being used for the decking will be used for the stair treads,

see Table 1 for span capabilities. When using two stringers, it is necessary to set the stringers closer together than the overall width of the stairs and cantilever the stair treads. As a general rule, 2-by stair treads can be cantilevered 5 inches. For stairs wider than the typical 3 feet, stringers should be placed at 16 inches on center when using 5/4 thick wood treads or composite treads and 24 inches on center when using full 2-by dimension lumber treads.

Handrails

Handrails shall be provided on not less than one side of each flight of stairs with four or more risers. The handrail shall be continuous the full length of the stairs and shall start at a point directly above the top riser of the flight and continue to a point directly above the lowest riser in the flight. The ends of the handrail shall be returned to the posts at the top and bottom of the stairs.

The handrail shall be between 34 inches and 38 inches above the nosing of the treads and shall be provided on at least one side of the stairway. There shall be a minimum clearance of 1-1/2 inches

Handrail geometry

Type I. Handrails with a circular cross-section shall have an outside diameter of at least 1-1/4" and not greater than 2".

If the handrail is not circular, it shall have a perimeter dimension of at least 4 inches and not greater than 6-1/4 inches with a maximum cross section dimension of 2-1/4 inches.

Minimum 1-1/2" clearance between handrail and adjacent framing

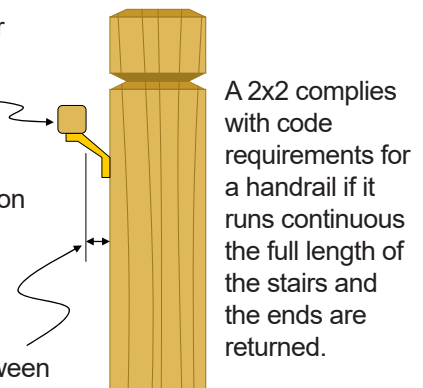

Figure 30

between the handrail and adjacent framing. Type I handrails shall have a circular cross-section with an outside diameter of at least 1-1/4 inches but not greater than 2 inches. If the handrail is not circular it shall have a perimeter dimension of at least 4 inches and not greater than 6-1/4 inches with a maximum cross section dimension of 2-1/4 inches. Edges shall have a minimum radius of 0.01 inch. This means 2x2 lumber with eased edges will meet the requirements of the code.

Inspections

Inspections are another part of the process. These inspections are done as a service to the homeowner and are required for all decks. Inspections should take place when various phases of the construction are completed. Where a deck is too close to the ground to verify the connection between the ledger and the house at the time of the inspection, then the deck shall be self-supporting.

Footing or pier hole inspections may be required before the concrete is placed. Remember that dry set concrete is not approved by most concrete manufacturers. The concrete needs to be properly mixed with the prescribed amount of water prior to placing for it to work properly and to meet code.

A separate framing (rough-in) inspection may be required if the under-floor framing and connections cannot be easily inspected during the final inspection. A final inspection is required after all the work is complete.

When scheduling an inspection, call 24 hours in advance to set up a time for the inspector to make his or her visit. The builder or homeowner is not required to be present for the inspections, but they are welcome to be there if they would like to be. If the homeowner is not going to be present, they must give the inspector permission to enter their property to complete the inspection or schedule it for a time when they can be there.

All information displayed in tables provided courtesy of the International Codes Council.

This publication was produced by TimberTek Consulting and is endorsed by the Johnson County Building Officials Association. It is published by the Johnson County Contractor Licensing Program for distribution throughout Johnson County. Jurisdictions within Johnson County wishing to obtain copies of this publication for distribution in their community should contact the Johnson County Contractor Licensing Program in Olathe, Kansas.

Plan

